

ANGLIČTINA PRO MÍRNĚ POKROČILÉ 1

FAKULTA
JADERNÁ
A FYZIKÁLNĚ
INŽENÝRSKÁ
ČVUT V PRAZE

Mgr. JANA KOVÁŘOVÁ, Ph.D.



FAKULTA
JADERNÁ
A FYZIKÁLNĚ
INŽENÝRSKÁ
ČVUT V PRAZE

KATEDRA
HUMANITNÍCH
VĚD A JAZYKŮ

PRAHA 2022

CONTENTS

UNIT 1	UNIVERSITY STUDIES	3
PART 1	CZECH TECHNICAL UNIVERSITY, FACULTY OF NUCLEAR SCIENCES AND PHYSICAL ENGINEERING.....	3
PART 2	THE UNIVERSITY OF SALFORD	10
UNIT 2	CAREER – CURRICULUM VITAE / RESUME	18
UNIT 3	PROCESS AND CYCLE DESCRIPTION	25
PART 1	HOW THINGS WORK (+ RELATIVE CLAUSES)	25
PART 2	CAUSE AND RESULT	29
PART 3	MOVEMENT AND ACTION (+ PASSIVE)	30
PART 4	PROCESS DESCRIPTION (+ USEFUL LANGUAGE, ACTIVE OR PASSIVE)	34
PART 5	CYCLE DESCRIPTION (+ IRREGULAR AND FOREIGN PLURALS)	40
UNIT 4	DEFINITIONS	48
PART 1	STRUCTURE OF DEFINITIONS	48
PART 2	TYPES OF DEFINITIONS	50
PART 3	VARIATIONS IN DEFINITIONS	55
LITERATURE, RESOURCES		57

UNIT 1

UNIVERSITY STUDIES

PART 1

CZECH TECHNICAL UNIVERSITY, FACULTY OF NUCLEAR SCIENCES AND PHYSICAL ENGINEERING

1. Czech Technical University (CTU)

The history of the Czech Technical University goes back to the beginning of the 18th century. It was then referred to as the Polytechnical Institute, being the first engineering institute in Central Europe.

Since 1920, the school has been known as České vysoké učení technické, still referred to in English as “The Czech Technical University“, although to call the school Czech University of Technology would be more appropriate. Prague had also a German Technical University, the original German part of the Polytechnical Institute, made famous by, e.g., Ernst Mach, the short presence of Albert Einstein, and others.

Our Faculty of Nuclear Sciences and Physical Engineering was founded in 1955, followed later by the independent Faculty of Architecture, and Faculty of Transportation Sciences. So, at present the University consists of 8 faculties:

the Faculty of Mechanical Engineering,
of Electrical Engineering,
of Civil Engineering,
of Nuclear Sciences and Physical Engineering,
of Architecture,
of Transportation Sciences,
of Biomedical Engineering,
of Information Technology.

2. Faculty of Nuclear Sciences and Physical Engineering (FNSPE)

The Faculty was founded in 1955. Its main responsibility has been to offer both undergraduate and postgraduate courses. In addition, the Faculty is also responsible for fundamental and applied research in fields related to nuclear physics, nuclear chemistry, nuclear power engineering, materials science, mathematics, software engineering, and physical electronics. Therefore it maintains close relations with various research institutions both at home and abroad.

While the head of the Czech Technical University is the Rector, assisted by several Vice-rectors, the academic administrative officer of each faculty is called the Dean, who chooses his Vice-deans. The Dean is responsible for the teaching and research (i.e., academic) conception of the school as a whole. Parts of the Vice-dean’s responsibilities are the teaching programmes and students’ matters. The Dean is also assisted by the Scientific Council. Each faculty also has an elected Academic Senate.

Non-academic matters are handled by the Dean’s Office. It consists of several administrative

departments, headed by their respective officers. The most important one for students taking the Bachelor's or Master's Degree Course is the Department for Student Affairs.

The current structure of FNSPE includes 10 academic Departments, namely of Mathematics, Physics, Languages, Nuclear Chemistry, Dosimetry and Application of Ionizing Radiation, Materials, Solid State Engineering, Physical Electronics, Nuclear Reactors, and Software Engineering in Economics, located either in Břehová Street (the main premises, housing also the Dean's Office and the Central Faculty Library) or in Trojanova Street or in Troja.

Although the Faculty shares the same basic structure in its degree courses as the other member faculties of the CTU, it is unique in several respects, namely:

- a) most students have a grammar school background;
- b) all undergraduates take full-time courses, i.e., no part-time programmes are offered.

3. Admission to the Faculty of Nuclear Sciences and Physical Engineering

Admission to all courses offered by the Faculty is subject to certain guidelines established by the Faculty; they may change according to the current situation. More detailed up-to-date information may be obtained from the Department of Student Affairs.

Higher education is open to all who have successfully passed a secondary school-leaving examination or hold an equivalent certificate. There is no restriction as to the residence of the students; thus also foreign students can be admitted. Education still continues to be free of charge, although repeated suggestions have been made that students should pay fees for tuition.

To be admitted, the applicant, i.e., the student applying for admission to a university, must send in his/her application by a given date, submitting also the secondary school record and later the results of the final school-leaving examination.

Applicants are admitted without any entrance examination, and so those who have satisfied the entrance requirements can enter the university, enrol, matriculate, and register for courses. If a student is dropped from the faculty for unsatisfactory results, he/she can be re-admitted in case he/she submits a new application. Undergraduates can also interrupt their studies for a limited period of time to study abroad.

4. Types of Courses

The enrolment figure, i.e., the number of undergraduates entering the Faculty each academic year, varies, but it can be as high as 500 or more undergraduates and 50 PhD students. There is a wide variety of academic degree programmes: six-semester Bachelor of Science courses, four-to-six-semester Master of Science degree courses and three-year PhD courses. To earn a higher degree of Master of Science, some students can continue their training for 2 or 3 more years after having been awarded the Bachelor Degree. The Master of Science Degree is equivalent to the traditional Central European Degree of Engineer (Ing.).

The Bachelor Degree programmes specialize more or less from the very beginning. Most courses are divided into a general course taken for 4 semesters (in the first and second year), comprising a core section of main subjects with certain options, and a specialized course beginning in the 5th semester (the third year). The programme for Nuclear Chemistry students specializes from the very start.

The core course may include lectures on, e.g., Calculus, Linear Algebra, Numerical Analysis, Physical Chemistry, Electricity and Magnetism, Mechanics, Special Relativity, Optics and Waves, Atomic Physics, Theoretical Physics, Thermodynamics, Statistical Physics, Information Technology, Languages (English and a second language, i.e., French/German/Russian/Spanish), etc. The chemistry students will take Mathematics, Physics, General / Organic / Inorganic / Analytical / Physical, and Nuclear Chemistry.

In the advanced courses, i.e., in 5th – 12th semester of the degree programmes students specialize in their chosen branch of study, and therefore join research teams of the respective department. During the 5th and 6th semester students work on their Bachelor's Degree project on a given topic. They will stay with the department until they have completed, presented, and defended their project, and graduated. Then, from the following semester, students who have satisfied the requirements for admission to a Master degree course can begin research for their Master of Science thesis (i.e., degree project). Programmes in the more advanced courses are flexible and adjust easily to new developments in science and technology.

The programme of instruction is very orthodox and traditional: students attend formal lectures, seminars, practicals, and laboratory sessions. Of course, the teaching and research staff are ready to offer consultations and discuss problems with the students any time they may need it.

The Faculty also offers PhD (i.e., Doctor of Philosophy) programmes. After completing research on a given topic, the PhD student is expected to submit a dissertation, defend it, and pass a rigorous examination. Then he/she is awarded a Doctor's Degree (PhD).

5. The Academic Year

The academic year begins in October or late September and ends in September of the following year. The semester system which is used in our country divides the academic year into 2 equal semesters of about 14 weeks each. Some universities abroad have a quarter system, dividing the academic year into 3 terms of about 11 weeks each, plus a fourth "summer quarter", or a trimester system of 3 terms. Each semester in our school is followed by an examination period of 6 to 8 weeks each. Most students take the summer off to work or travel, so July, August, and often even September, are traditional long vacation months.

In order to receive a "zápočet" and take examinations, and thus accumulate the required number of credits, undergraduates (i.e., students studying for their first degree – the Bachelor's Degree) and postgraduates (i.e., students studying for a higher qualification – the Master's Degree) must be properly registered for each academic year. This includes both registering, or signing up, in the Department of Student Affairs for each course offered and chosen from the list in the faculty prospectus in the respective year or semester, and having the registration confirmed in the course record. The prospectus (in the US referred to as "the catalog") also informs about the number of credits and the examinations to

be taken at the end of the winter and summer semester.

Instructors give a “zápočet” for each course to undergraduates who have qualified for it by the academic performance through the semester (i.e., who have satisfied the requirements: participated in class discussions, in due time handed in the assignments and papers, performed well in the tests and quizzes, gave a presentation, etc. In some courses, a search must be carried out on a given topic). The assessment is continuous. Only after obtaining the “zápočet” are the students eligible to sit for an examination in the respective subject. Thus “the zápočet” in our system of higher education is a kind of screening before the formal examination. The credit system of points attached to each course has been introduced quite recently.

The quizzes, tests, the “zápočet”, the credits, and examinations are a measure for both the student and the teacher of how much and how well the student is learning. The quality is measured by marks (grades in the US), namely the passing marks:

A - excellent

B - very good

C - good

D - satisfactory

E - sufficient

Mark F is a failing mark (F=failed). In the case of failure, the student can retake, or resit, the examination two more times. The quantity of the student’s work is measured by the number of class hours per week and number of examinations and other academic work per semester.

6. Student and Staff Services

The University and its Faculties have special support facilities offering services to their students and staff. They are provided by, e.g., the Libraries, the Halls of Residence, (Dormitories in American English), the University Publishing House, and the Medical Centre.

Library

The brand new Technical Library has been opened in Dejvice, but our Central Faculty Library is still located on the main premises in Břehová Street. It contains an extensive collection of books and periodicals covering the study programmes and research projects of the school. It also shelves reference books, journals, newspapers, lecture notes, proceedings, dictionaries, degree projects, PhD dissertations, etc. Lecture notes and many books may be taken out on loan, but dictionaries and some textbooks are available for reference use only.

Computer Rooms

ELSA Centre

ELSA is the support centre for students with special needs that helps people with a disability, dyslexia, dysgraphia, etc. ELSA is a workplace attached to the Department of Studies and Student Affairs of CTU in Prague. In support of students with special needs, ELSA provides services to ensure that they can benefit fully from their studies. The digitizing and library service provides access to study literature, including adapting specialized symbols and transforming materials to a tactile form. For students with hearing difficulties, there is a visualizing and transcribing service and also an interpreting service. The assistance

offered by ELSA covers assistance with studies, personal assistance and spatial orientation training. Through the organisational and methodological service, students receive training in study and work strategies (if these need to be supplemented), as well as individual tuition when needed. The technical service provides access for students to technical equipment in accordance with their type of disability, including the opportunity to loan certain equipment. An integral part of the services that are provided is sufficient advice and help to ensure that students make effective use of the ELSA services and understand what ELSA can offer in the context of their studies.

Accommodation and Meals

Full-time non-residential students who live too far to commute can apply for accommodation in the university halls (of residence). The room charge can vary according to the quality of housing. Most halls provide shared study-bedrooms, usually doubles. Cheap private housing is difficult to find.

Meals at reduced prices are available in the Refectory (dining room) of the halls, or they may be taken in the university cafeterias ("menzas"). Most halls provide all daily meals except weekday lunches. Meal tickets (vouchers) for the whole month can be obtained from the respective cafeteria office.

EXERCISES

I. Explain the following phrases in English.

1. higher education is open to all
2. to possess a grammar school certificate
3. to demonstrate proficiency in the Czech language
4. education is free of charge
5. unsatisfactory results
6. to apply no later than
7. to be dropped from the faculty
8. to sit for an exam
9. to compile a search
10. to fail an exam

II. Find the proper expression for the following explanation:

1. the most common method of instruction at university
2. the instruction in a laboratory
3. to complete successfully a degree course
4. the number of students at a university
5. a long-term written project to finish a master degree course

III. Fill in the missing prepositions (if any):

1. The school is often referred as the Czech Technical University.
2. The CTU was founded the beginning of the 18th century.
3. It trained engineersthe ideas of those days.
4. After changes structural patterns, the school was divided faculties.
5.1899 another university was founded Brno.
6. Our faculty was established much later
7. Some faculties were transformed independent schools.

8. Our faculty is responsible teaching and research.
9. The Dean's office consists several departments.
10. The current structure the faculty includes 10 academic departments.
11. FNSPE is unique several respects.
12. The 3rd year students join research teams their respective departments.
13. The academic year is divided 2 semesters.
14. Each semester is followedan examination period.
15. Students must be properly registered each academic year.
16. If a student does not qualify a credit, they may not sit an examination.
17. Credits are a kind of screening the examination.
18. The year project is based research.
19. The mark the student earns a project may influence the examination results.
20. The student's workload the university is measured in class hours.
21. The number of examinations semester should not be higher than five.
22. Students are supposed to participate class discussions.

IV. Find possible collocations:

1. to a credit
2. to for a "zápočet"
3. to an exam
4. toa course
5. to for a course
6. to all requirements
7. to in class discussions
8. to assignments

V. Match the terms and explanations:

- | | |
|------------------|---|
| 1. academic year | A. the number of hours students spend in class |
| 2. class hour | B. a piece of writing on a particular subject written by an expert and usually published in a book or journal |
| 3. semester | C. evaluation of a student's academic work |
| 4. paper | D. a period of study of about 13 weeks |
| 5. "zápočet" | E. a period of formal instruction beginning in October ending in September |
| 6. assignment | F. out-of-class work required by the instructor and due by a given date |

Vocabulary to study

<p>assessment to found to relate (ex.: these two facts are closely related) to maintain to handle smth students' matters i. e. e. g. etc. admission (to courses) assignment dean to admit to obtain thus, therefore to apply for tuition applicant, application to interrupt studies (academic) department</p>	<p>to enrol on, for/in to award smb / to be awarded the Bachelor Degree comprise graduate in graduate / postgraduate (<i>both nouns</i>) graduate with distinction / honours lecture thesis dissertation rigorous examination sufficient hall of residence/ dormitory a brand new library to satisfy the requirements mature student supervise, supervisor core course to commute voucher cafeteria</p>
---	--

Notes:

undergraduate = a student at a college or university studying for their first degree

graduate = someone who has completed a university degree, especially a first degree; in American English also somebody who has completed a course at a college, school etc. (example: a high-school graduate)

postgraduate = someone who is studying at a university to get a Master's degree or a PhD (especially in British English); in American English "graduate student"

mature student = a student at a university or college who is over 25 years old (British English)

PART 2

THE UNIVERSITY OF SALFORD

The University stands in the City of Salford, some two miles to the west of the centre of Manchester, which is easily reached by car, public transport or on foot. The University is fortunate in having the facilities of two cities so close at hand. Salford caters for the day-to-day needs of most students and Manchester, England's third largest city, provides excellent cultural, leisure and sporting facilities. The University occupies an attractive 34-acre single-site campus on the banks of the River Irwell, with most of its buildings surrounding Peel Park. The layout of the central campus is shown below. The Peel, Tower and Maxwell Buildings are grouped around the lawns in front of the Salford City Art Gallery, Museum and Library, which face the main A6 motorway. Behind these buildings are the Cockcroft Building, the University Library and University House, the latter accommodating the Students' Union, a sports hall, and dining, lounge and bar facilities for staff and students. The Chapman lecture theatre suite stands at the edge of the campus and near to the Newton Building, which houses the Department of Aeronautical and Mechanical Engineering. The Telford, Smeaton and Brindley Buildings lie on the east bank of the River Irwell and house the Department of Civil Engineering and the Departments of Economics and Geography. An elegant modern footbridge provides access to the main campus through Peel Park which forms a surprisingly pleasant and quiet haven at the core of the University. The Departments of Modern Languages and Sociological and Political Studies now occupy Crescent House, situated on the far side of the A6. Away from the campus, temporary premises in Meadow Road accommodate the Department of Applied Acoustics. Some of the work of the Department of Biology is undertaken at Gardner Street. The University can provide places for a high percentage of its students in University-owned or controlled Halls of Residence, self-catering flats or student houses and most of the accommodation is within walking distance of the campus. The University has three faculties covering the areas of engineering, science and social sciences and arts. In 1988/89 there were 3,816 full-time students, of whom 508 were postgraduates, and there were 698 part-time postgraduates. The University attaches particular value to part-time study for higher degrees, and the majority of programmes and research opportunities are open both to full-time and part-time students. It has strong links with industry, commerce and the public sector and a significant percentage of its research work is funded from these sources.

From the University of Salford Undergraduate and Postgraduate Prospectus

EXERCISES

I. After reading the above text carefully, divide it into paragraphs.

II. Pay special attention to the words and phrases describing location, esp. the words: to house, to accommodate, to occupy

The building	houses accommodates	the office
The office	occupies	the building

III. The following description is correct but the style is too simple. Instead of There is / There are, try to improve on the style by using more descriptive verbs such as

consist of
occupy
house

contain
accommodate
provide

(Leave the first and last sentence unchanged.)

The Institute for Great Discoveries is situated within easy reach of public transport. There are three buildings set in a beautiful park. There is the director's office and the rooms for the administrative staff in the smallest building. There are two lecture halls and the library in the large circular building. There are 200 seats in the large lecture hall and 30 seats in the small one. There are laboratories and study rooms for scientists and researchers in the third building. There are also dining and bar facilities for the staff in the Institute. There are excellent shopping facilities within walking distance of the Institute.

IV. Match the following verbs with their correct meaning.

- | | |
|---------------|---|
| 1. consist of | a) to have as part or member, to contain in addition with other parts |
| 2. include | b) to have within itself |
| 3. contain | c) to have as the parts or material, to be made up of |

V. Fill in the gaps with the correct verbs (**consist of**, **include**, **contain**):

- 1) All plastics _____ very large molecules.
- 2) The price of accommodation _____ breakfast.
- 3) This books _____ important information.
- 4) The United Kingdom _____ England, Scotland, Wales and Northern Ireland.
- 5) Your duties will _____ writing detailed reports on all experiments.
- 6) The committee _____ five members.
- 7) The library _____ ten thousand volumes.
- 8) Our working hours _____ a break for lunch.
- 9) This sample of water _____ many organic compounds.
- 10) Water _____ two parts of hydrogen and one part of oxygen.

VI. Use correct forms of the following verbs to fill in the sentences:
benefit from, be known for, be located, be set, be strong in, enjoy, lie, offer, provide, specialise in

- 1) The campus _____ about a mile from the centre of the city.
- 2) The university _____ a good range of subjects.
- 3) The campus _____ in a peaceful environment.
- 4) The university _____ its wide-ranging programme of cultural events.
- 5) The university _____ the social sciences.
- 6) The campus _____ to the west of London.
- 7) The student's union _____ a wide range of live music events.
- 8) Students _____ the flexibility of the modular system.
- 9) The university _____ a high quality education.
- 10) The students _____ all the advantage of living in a cosmopolitan city.

VII. The following words are often used incorrectly by Czech speakers, as they resemble some Czech words. Using a dictionary, find the correct translation of so called "false friends".

gymnasium		gymnázium	
physician		fyzik	
college		(studentská) kolej	
high school		vysoká škola	
*cathedra / cathedral		katedra, katederní	
term		termín	
control		kontrolovat	
economical		ekonomický (e. vývoj)	
maturity		maturita	
absolve / *absolvent		absolvovat, absolvent	
promote, promotion		promovat, promoce	
*red diploma		červený diplom	
desk		deska	
fabric		fabrika, továrna	
function		funkce (zastává funkci ředitele)	
chef		vedoucí / šéf	
pension		penze (je v penzi)	
technique		technika (strojírenská t.)	
approbation		aprobace	
script		skripta	
engineer			

Note: The words with * do not exist in English.

Be careful with the words **graduate (noun), postgraduate, diploma**.

REVISION

FORMING QUESTIONS

I. Form questions referring to the expressions in italics:

- 1) *An electronic device* controls the speed of the engine.
- 2) *Gilbert Hyatt* is the inventor of the microchip.
- 3) *These measures* prevent *farmers* from introducing modern farming techniques. (2 different questions)
- 4) The trouble first became known *in 1985*.
- 5) *Pain* is the most common reason for going to a doctor.
- 6) *Scientists* re-examined *the information that had been gathered by satellites*. (2 different questions)
- 7) Most of Earth's plant and animal species live *in rain forests near the equator*.
- 8) *The national weather service* sends weather maps to its local offices.
- 9) Cold fusion experiments continue to be made *in many laboratories*.
- 10) In 2000, *the study group* published a report on their experiments.
- 11) The ozone layers decreased *much more severely* during winter months than in warmer months.

II. Write down the words in the correct order to form questions.

- 1) weather – people – how – does – affect
- 2) parts – what – of – they – are – made
- 3) people – project – many – how – the – on – worked
- 4) Britain – parks – many – national – how – there – in – are
- 5) companies – industries – efficient – successful – privatised – state-owned – more – are – than – and
- 6) people – house – other – your – many – how – in – live
- 7) part – operation – difficult – most – what – the – the – of – was
- 8) calculators – microchip – big – would – without – how – the – be
- 9) problems – study – your – you – with – helps – who
- 10) damage – visitors – landscape – kind – many – what – cause – of – to – the – too – do
- 11) room – whom – you – share – a – with – do
- 12) home – work – come – usually – he – when – from – does
- 13) people – Internet – country – many – this – do – the – in – use
- 14) people – Internet – country – many – this – the – in – use – how

EXERCISES – UNIVERSITY EDUCATION

I. Put the words in the box into the correct category.

cafeteria seminar hall of residence research assistant
counsellor sports grounds office hours lecture theatre
tutorial senior lecturer head of department dormitory
lecturer tutor professor supervisor

people	place	event

II. Fill in the missing words in the e-mail below. You may use some of the words from the exercise above.

Hi Clara,

I've settled well here at Salford. I like my room in this hall of I went to my first this morning – it was on research methodology – and there were hundreds of students there. The was very good – it was Professor White, our head of Tomorrow I'll have my first – that'll be just me and one other student. We'll be discussing what we have to get done by the end of the I need to think some more about the topic for my When that is finalised I'll be assigned a I'll be expected to see him or her at least once a week during their office I hope I'll like him or her. You hear some awful stories!

Sarah

III. Complete the table below. Use a dictionary to check the words.

verb	noun	adjective
opt		
		obligatory
	supervision +	
	assessment +	-----
-----		eligible

IV. Find suitable words and fill in the gaps:

The American educational system is based _____ the idea that as _____ people as possible should have access _____ as much education as possible. This fact alone distinguishes the U.S. system _____ most others, since in most others the objective is as much to screen people out as it is to keep them in. The U. S. system has no standardized examinations _____ results systematically prevent students _____ going on to higher levels of study, as the British and many other systems do. Through secondary school and sometimes in post-secondary institutions as _____, the American system tries to accommodate students even if their academic aspirations and aptitudes are not high, _____ if they are physically (and in some cases _____) handicapped, and even if their _____ language is not English.

V. Fill in the prepositions:

The brain is divided _____ two hemispheres. It consist _____ the right and the left hemisphere. The two hemispheres are connected _____ the 'corpus callosum'. This allows the two hemispheres to communicate _____ one another. The knowledge _____ the brain goes back _____ the ancient Egyptians. They noticed how injuries to one side of the brain caused damage _____ the opposite side of the body. Marc Day found that speech was controlled _____ the left hemisphere. Recently scientist have found that both hemisphere are essential _____ integrating information.

VI. Study the difference between the following words:

TECHNIQUE X TECHNOLOGY

a) Study the table showing the meaning of the Czech words "technika" and "technologie" and their equivalents in English.

TECHNIKA	a)	oblast lidské činnosti vyučivající výsledků vědeckého poznání pro výrobu či pro získávání materiálních hodnot (např. rozvoj současné vědy a t.)	TECHNOLOGY
	b)	obor pracovní činnosti, který vyžaduje vědeckou metodu a znalosti (sdělovací t., raketová t., měřicí t., obalová t.)	TECHNOLOGY
	c)	způsob provádění výrobní, umělecké, sportovní aj. činnosti (např. t. práce, hlasová t., t. skoku dalekého)	TECHNIQUE
	d)	praktická odborná dovednost (např. překladatelská t., hráč s dobrou t.)	TECHNIQUE
	e)	strojní vybavení (např. firma je vybavena moderní t.)	EQUIPMENT
	f)	vysoká škola technického zaměření (poněkud zastarale)	college of technology, Technical University (BE), Institute of Technology (AE)
TECHNOLOGIE	g)	postup při zpracování materiálu na určitý výrobek	TECHNOLOGY

b) Read the following examples and match them with the letters (meanings) above.

1. modern management techniques
2. our belief in the power of modern technology
3. They don't have the technique to express all that in written form.
4. advances in technology and science
5. changes in agricultural technology
6. he owed her technique entirely to his teaching.
7. information technology
8. computer technology
9. The young artist has imagination but needs to improve his technique.

INŽENÝR X ENGINEER

a) Study the difference in meanings of the Czech word "inženýr" and the English word "engineer".

INŽENÝR	ENGINEER
a) vysokoškolsky vzdělaný odborník tech., ekon., zeměd. ap. směru; titul absolventa příslušné vysoké školy	a) a skilled person whose job is to design or build roads, bridges, machines, engines etc.
	b) an officer responsible for the engines on a ship or aircraft
	c) a mechanic, someone whose job is to repair electrical equipment or machines (such as central heating system etc.) (BE)
	d) the driver of a railway locomotive
	e) a soldier who is in a regiment responsible for building bridges, roads etc.

b) What English word matches the meaning of the Czech word "inženýr" (Ing.)?

TECHNIK X TECHNICIAN

a) Compare the meaning of the Czech word "technik" and the English word "technician". Can you find meanings which match?

TECHNIK	TECHNICIAN
a) člověk s technickým vzděláním, kdo se zabývá techn. obory	a) someone whose job is to check equipment or machines and make sure they work properly
b) ten, kdo provádí technické práce (např. stavební, důlní, divadelní t.)	b) a worker trained with special skills or knowledge, especially in science or engineering; a person who knows how to operate machines or equipment used in science (laboratory technician, X-ray technician)
c) kdo dokonale ovládá technickou stránku činnosti, techniku (zvl. ve sportu či umění) (např. hokejový útočník musí být dobrý technik)	c) someone who is very good at the skills of a particular sport, music, art etc.

Note: A **technician** often works in a narrower field than an **engineer**; a **mechanic** generally deals only with mechanisms, although the terms are interchangeable.

Examples: computer engineer, dental technician, car mechanic

UNIT 2

CAREER - CURRICULUM VITAE (CV) / RESUME*

A good curriculum vitae [kə' rɪkjələm 'v i:tai] or resume ['rezjʊmeɪ] **should**

- ✓ always be targeted
- ✓ include only relevant facts
- ✓ provide all the necessary facts
- ✓ be true
- ✓ have a proper layout (usually within 1 page only)

A good CV will contain:

Personal Details/Personal Data

- First name + surname
- (Date of birth, Place of birth, Nationality, Marital status)
- Address -present and permanent
- Telephone number
- E-mail address

Education

- time + name and location of school + type of course + branch of study, specialization (+ final examination)
*N. B. Usually a reverse chronological order is used.
Primary (basic) education is not included.
Specialized courses may be included.*

Work Experience/Professional Experience

- time + name and location of institution + kind of job + position + duties performed

Additional Skills/Relevant Skills/Special Skills

- knowledge of languages (level, examinations)
- computer skills
- driving licence
- other (certificates, diplomas)
- abilities

Interests

- professional (related to the job or profession or position)
- other

References/Referees

- name of referee + institution + position + contact
N. B. Often only a phrase "available upon request".

* curriculum vitae = British English; resume = American English

Useful vocabulary

obor	branch
specializace	specialization (<i>NOT specialty</i>)
praxe	hands on training (<i>NOT practice</i>)
(při studiu; např. ve firmě; v „reálném“ prostředí)	
brigáda	summer job, holiday job / part-time job (<i>NOT brigade</i>)
exkurze	field trip (= 1 day), extended stay at... (longer than 1 day) (<i>NOT excursion</i>)

EXERCISES – CV, APPLYING FOR A JOB

I. This is an example of a CV written by a job applicant. Fill in the headings and organize it in a correct order.

2003 – 2004	London Chamber of Commerce and Industry Diploma in Public Relations
2000 – 2003	London School of Economics and Political Sciences B.A. in Media and Communications
1993 – 2000	Fettes College, Edinburgh A-levels in English (A), German (A), History (B), and Geography (A)

environmental issues, reading, orienteering, cross-country skiing, swimming

available upon request

fluent in German
working knowledge of Italian
driver's licence (car and motorcycle)
ski instructor (grade 3)
orienteering national champion

Name: Sheila Britton
Date of birth: 2nd August, 1981
Place of birth: Edinburgh
Address: 2 Endon Drive
Chorlton, Manchester M21 7TE
Telephone: 01612477403
E-mail address: britton@aeol.com

Responsible for writing articles on the Trust's activities and for distributing them to the press.
Editing the Scottish Wildlife Magazine and educational publications and preparing the 2007 SWT calendar.
Maintaining relations with international environmental agencies.

2004 to present Scottish Wildlife Trust (SWT)
Department of Public Relations

summer 2001, 2002 Training period as assistant editor with the Guardian

II. Look at more examples:

CURRICULUM VITAE

Name: Michael Woods

Address: Flat 5, 20 Park Road,
London N4 3JY

Tel: 0208 848 4065

Email: MWoods@aol.com

Date of Birth: 6-6-77

Qualifications: Higher National Diploma in Computer Studies,
University of North West London (1998)
A Levels: Maths (C), English (E) (1995)
O Levels: Maths, English Language, Chemistry,
General Studies, Woodwork (1993)

Employment History: Asst. Technical Support Manager,
Pearl Publishing (2001-now)
Support Analyst/Programmer, Mayfair Books (1999-2001)
Programmer, Mayfair Books (1998-1999)

Interests: Salsa dancing, running, gardening.

Referees: Ms Ingrid Hoyer, IT Manager,
Pearl Publishing,
44 Lower Street,
London N1 3XY
Dr Paul Jones,
Senior Lecturer,
Dept. of Computer Studies,
University of North West London,
Downland Road,
London NW2 6HM

Curriculum Vitae/CV (in British English)

2334 Greenwood Road Tel: (505) 555-4965
Los Angeles, CA 90044 Email: MWoods@aol.com

Michael Woods

Objective To find a technical support position in the field of publishing.

Experience 2001 - present Pearl Publishing Los Angeles, CA

Technical Support Manager

- Managed IT support staff of eleven people.
- Led regular training seminars.
- Redesigned company-wide help desk procedures.

1999-2001 Mayfair Books Southridge, WA

Systems Administrator

- Managed LAN network.
- Implemented training course for new analysts.

1998-1999 Mayfair Books Southridge, WA

Information Technology Associate

- Maintained computer systems of editorial and design staff.
- Worked on team of twenty IT associates to improve overall operations.

Education 1994-1998 Southridge State University Southridge, WA

- B.S., Computer Science.
- Graduated Summa Cum Laude.

Interests Salsa dancing, running, gardening, carpentry, computers.

References Available upon request

Résumé (in American English)

(Image taken from Cambridge International Dictionary of English, 1996.)

III. Look at the curriculum vitae below. What can be improved there?

Alan Turing

Home Address:

33 Union Street,
Bletchley Park,
B6 3AE.

Term Address:

6 Farthings Court, Parkwood
Canterbury
CT2 8NP

Tel. (0161) 351 4039

Nationality: British

Email: at5555@kent.ac.uk

EDUCATION AND QUALIFICATIONS

University of Kent BSc (Hons.) Computer Science 2010 - 2013

Subjects include:

Software Engineering, Compiling Techniques, Cryptography, Digital Systems, Operating Systems and Robotics.

I obtained 62% in my 2nd year exams equivalent to a 2:1

My project involved the development of a Linux-based code breaking system and required independent research skills

Sherborne College 2008 - 2011

'A' Levels: Mathematics A, Physics C, Chemistry D.

St. John's Boys School, Hastings. 2003 - 2008

8 GCSEs including Mathematics, English and German.

WORK EXPERIENCE

Tourist Information Office, Canterbury Summer 2011

Assisting customers from all over the world with a wide variety of enquiries, working in the Bureau de Change, booking theatre and concert tickets.

Hastings City Council Summer 2009

Temporary Accounts Clerk in City Treasurer's office. Responding to customer enquiries, using computerised accounts systems.

Simple Simon's Public House, Canterbury. Sept. 2011 - present

Part-time barwork throughout the year serving customers and cashing up.

ACTIVITIES AND INTERESTS

- Secretary of the Cryptography Society, involved booking speakers.
- Helped to organise a charity fun run for Rag Week
- Have fundraised for the World Land Trust who buy and save endangered rainforests.

- With a passion for finding eye-catching images, photography has become an interest of mine. With self-motivation, I have taught myself how to use Photoshop, and I have created my own website
- Other interests include current affairs and reading sci-fi novels.

ADDITIONAL INFORMATION

- **Computing Skills:** Knowledge of Linux and Windows 7. Programming skills in Java, Haskell and Modula 3. Good knowledge of SQL and XML.
- Good level of spoken German.
- Full, clean driving licence.

REFEREES : I am happy to supply these on request.

Source: <http://www.kent.ac.uk/careers/cv/cv1.htm>

IV. Insert the following words in the gaps in the text below:

applicant - application - application form - apply for - candidate - CV - employment agencies - interview - job description - job vacancies - references - short-listed

Many people looking for work read the advertised in newspapers by companies and
 To reply to an advertisement is to a job. (You become aor an). You write
 an, or fill in the company's, and send it, along with your and a covering
 letter. You often have to give the names of two people who are prepared to write for you.
 If your qualifications and abilities match the, you might be, i.e., selected to attend an

V. The CV below is full of common mistakes. Identify & correct them.

CURRICULUM VITAE

PERSONAL DETAILS

First name: Martin

Second name: Zelený

Majerova 8, Brno

Slavnickova 750/4, 150 00 Prague

21. 8. 1995

Czech

mazelen@gmail.com

606 554 332

QUALIFICATIONS

2013 – 2018 Czech Technical University, Department of software engineering in economics, my specialty is "IT applications in banking"

*2008 – 2013 Grammar school in Třebíč
mathematics A, english B, physics A
graduation*

WORK EXPERIENCES

2013 - 2014 private teacher – teaching physics to high-school students

22. 4. – 29. 9. 2014 Hopp, s.r.o. – IT administrator

12. 2. 2015 - ČNB – work like junior IT specialist

INTERESTS

sport – I think it is important to lead a healthy lifestyle

friends – I love spending my free time talking to my friends

books – I'm especially fond of classical literature

news in science

programming

SKILLS

good knowledge of English and Germany, computing skills: MS Office, LaTeX, C++, reliable, hard-working, native language Czech, cooperation, expressing ideas, driving license B

UNIT 3

PROCESS AND CYCLE DESCRIPTION

PART 1

HOW THINGS WORK

RELATIVE CLAUSES

In order to avoid repeating a subject, a relative pronoun and relative clauses are used. Observe how two simple sentences change into a complex sentence (containing one main clause and one dependent clause):

The bark is stripped from the trunks. The trunks are sawn into logs. → The bark is stripped from the trunks, which are sawn into logs.

I. Study the difference between three types of relative clauses.

A	B	C
The woman <u>who lives next door</u> is a doctor. Grace works for a company <u>that makes furniture</u> . We stayed at the hotel <u>(that) you recommended</u> .	My brother Ben, <u>who lives in Hong Kong</u> , is an architect. Anna told me about her new job, <u>which she's enjoying a lot</u> . We stayed at the Park Hotel, <u>which a friend of ours recommended</u> .	Susan could not meet us, <u>which was a shame</u> . The weather was good, <u>which we hadn't expected</u> . Ian came on time, <u>which surprised me</u> .

II. Identify relative clauses in the text below. Decide which type (A, B or C) each clause is.

The diagram shows how a hydraulic lift works. The system is quite simple and consists of the lift carriage, where passengers stand, connected to a piston which raises and lowers the carriage and a tank that holds hydraulic fluid.

III. Read the sentences and add commas where necessary.

- 1) The lift carriage which is attached to the top of the piston is also forced up.
- 2) Only the straws that get blocked will eventually become stalactites.
- 3) The condition in which the poorest sector of the population lived were bad.
- 4) He spent many years trying to create a machine that would automatically sort large numbers of coins.
- 5) Our flight was delayed which meant we had to wait three hours at the airport.
- 6) If a customer offers to pay for the good by credit card the merchant has to request for the payment to be authorised by the credit card organisation which must also request authorisation in turn from the consumer's bank.

- 7) A machine whose task is to generate electricity is called a turbine.
- 8) The turbine which is rotated by the pressure of the air generates electricity.

IV. Connect the information to make sentences with relative clauses (non-defining or defining).

Example: There is a young man living next door to me. He is a doctor.

The young man who lives next door to me is a doctor.

- 1) There is a container. It is made of steel. It catches the rain water.
- 2) Chlorine is added to the tank. It kills any dangerous bacteria.
- 3) The pages pass through a machine. It cuts off the edges.
- 4) The programming takes six months. It is done in India.
- 5) The mixture is heated to a temperature. The temperature causes a chemical reaction.
- 6) A job was advertised. A lot of people applied for it. Few of them had the necessary qualifications.
(Start with: Few of...)
- 7) There was a railway strike. It began a week ago. It is now over. (Start with: The railway strike...)
- 8) I have had my car for fifteen years. It has never broken down. (Start with: My car...)
- 9) My colleague has a son. She showed me his photo. He is a pilot. (Start with: My colleague showed me...)

V. Some of these sentences are wrong. Correct them and put commas where necessary.

- 1) My friend told me about his new job that he is enjoying very much.
- 2) My office that is on the third floor is quite tiny.
- 3) The office I am using at the moment is very small.
- 4) Daniel's mother that used to be a kindergarten teacher now works at the local administrative.
- 5) The doctor that examined me could not find anything wrong.
- 6) The sun that is one of millions of stars in the universe provides us with heat and light.

RELATIVE PRONOUNS:

WHO/THAT refer to people (and pets).

WHICH/THAT refer to things and animals.

WHOSE refers to the possessive of persons.

WHOM refers to persons and is often used with a preposition. It is used in other cases than „nominative“. (Note that a category of case (*česky: mluvnický pád*) is not applicable in English.) This form is frequently being substituted by “who” nowadays.

RELATIVE ADVERBS: WHEN, WHERE, WHY

VI. Complete the sentences with one of the following relative pronouns: **that, which, who, whom, whose**. Add commas where necessary.

- 1) My supervisor _____ seems very young has just been promoted to head of department.
- 2) The article _____ I have just finished reading is very clearly written.
- 3) The research _____ I finished last year has just been published.
- 4) The lecturer _____ name I always forget was as boring as usual this morning.
- 5) The student with _____ I share a room is very noisy. (formal)
- 6) The student _____ I share a room with is very noisy. (informal)
- 7) However, in the fifteen to twenty-four age group many of _____ had probably benefited from education since 1975 the figures were 7.7 and 24.7 per cent respectively.
- 8) A survey _____ purpose was to discover the type of academic writing _____ was expected of the students by their supervisors or tutors was conducted among overseas postgraduate students.
- 9) In Bavaria most of _____ was overwhelmingly Catholic by far the greatest unrest was provoked by the crude attempt to remove crucifixes from school classrooms.

VII. Write the relative clauses in a more formal way using a preposition + **whom/which**.

Example: Yesterday we visited the Natural Science Museum, which I had never been to before.

→ Yesterday we visited the Natural Science Museum, to which I have never been before.

- 1) My friend showed us her new laptop, which she is very proud of.
My friend showed us her new laptop...
- 2) This is a picture of my colleagues Tom and Hannah, who we went to the conference with.
This is a picture of my colleagues Tom and Hannah...
- 3) The party, to which only close friends were invited, took place on Wednesday.
The party,, took place on Wednesday.

VIII. Use the information in the first sentence to complete the second sentence. Use **all of /most of** etc. or **the ... of + whom/which**.

Example: All of Clara's sisters are married.

Clara has three sisters, all of whom are married.

- 1) Most of the information we were given was useless.
We were given a lot of information,
- 2) None of the eight people who applied for the job had the necessary qualification.
Eight people applied for the job,
- 3) Daniel hardly ever uses one of his computers.
Daniel has got two computers,
- 4) Matthew won £ 200,000 in a lottery. He gave half of it to his parents.
Matthew won £ 200,000 in a lottery,

- 5) Both of Eve's brothers are engineers.
Eve has got two brothers,
- 6) Patrick replied to neither of the e-mails I sent to him.
I sent Patrick two e-mails,.....
- 7) Kathleen went to the seminar – she knew only a few of the people there.
There were a lot of people at the seminar,
- 8) The sides of the road we drove along were lined with trees.
We drove along the road,
- 9) The aim of the company's new business plan is to save money.
The company has a new business plan,

PART 2

CAUSE AND RESULT

I. Look at the diagram below. What cause and result relationships are shown there?

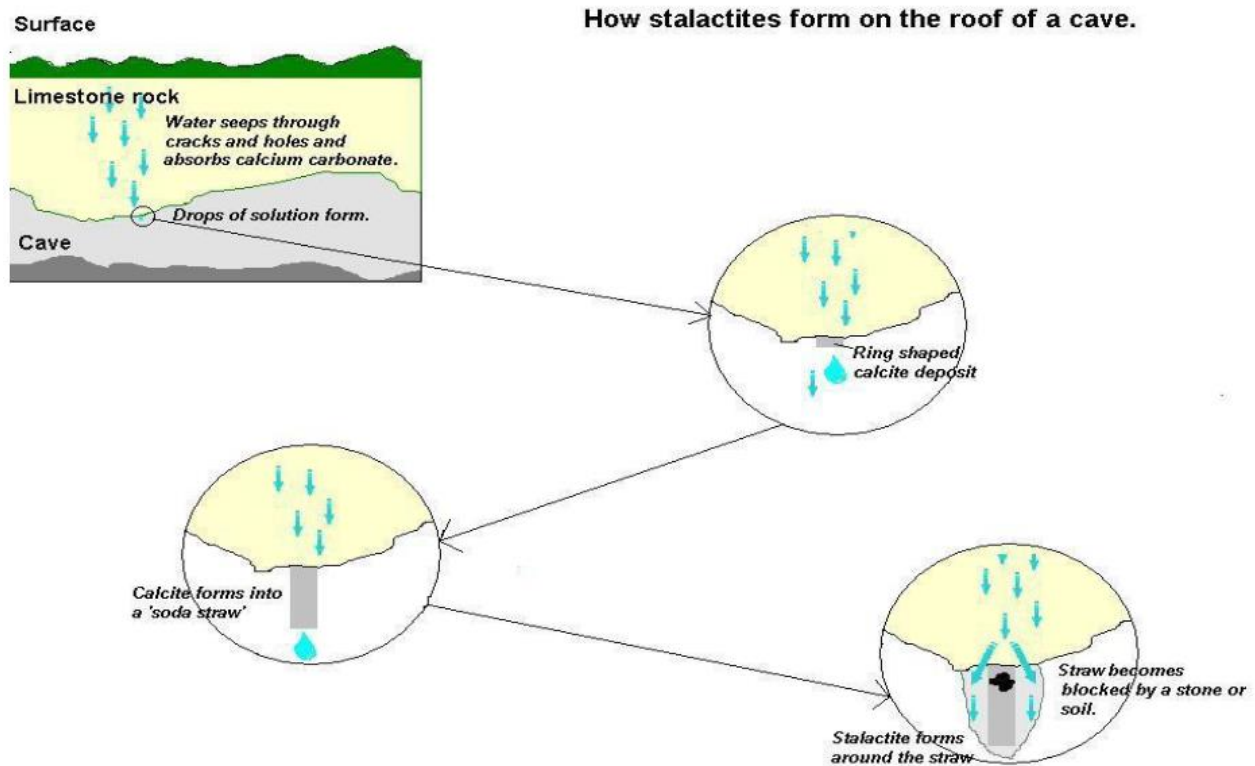

II. Complete this description of the process by using words and phrases below.

as a result, because, causes, consequently, due, give rise to, on account of, results in

Water leaks slowly into the cave 1..... there are thousands of tiny cracks and holes in the limestone rock. On its way down, the water absorbs the calcium carbonate present in the rock and this 2..... a mineral solution. Small drops of this solution form on the roof of the cave. When each drop falls, it leaves behind a ring-shaped deposit of calcite. This process is repeated many times and 3..... a thin calcite tube is formed. This tube is sometimes called a soda straw 4..... its shape. Occasionally the soda straw gets blocked 5..... to a piece of stone or soil. This 6..... the drops of solution to pour down the outside of the straw. 7....., calcite deposits build up around the straw and these 8..... the typical cone shape of the stalactite. Only the straws that get blocked will eventually become stalactites.

PART 3

MOVEMENT AND ACTION

PASSIVE

1. Which words are used to describe these actions?

- bend
- fall
- lift off
- lower
- pull
- push
- push/press
- raise/lift
- rise
- slide
- swing
- tighten/loosen (twist/turn)
- turn/rotate (used transitively)
- turn/rotate/revolve (used intransitively)
- twist

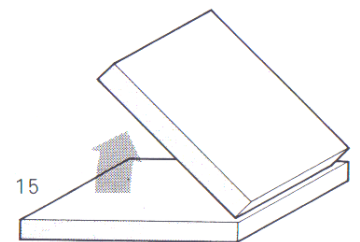
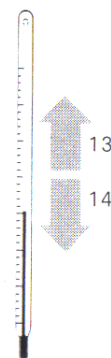
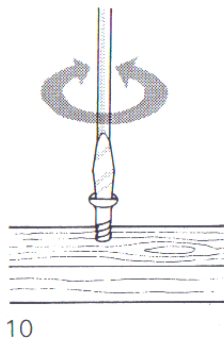
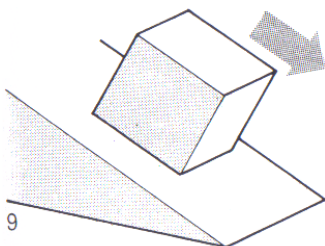
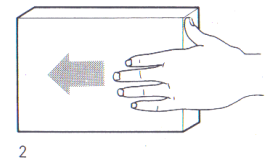
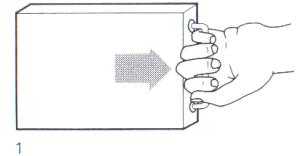
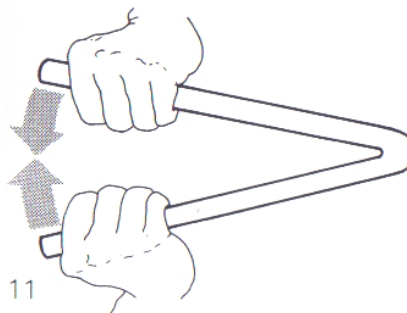
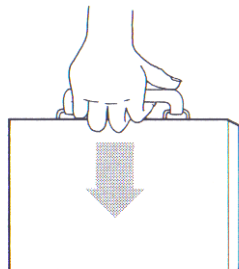
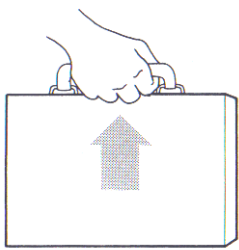
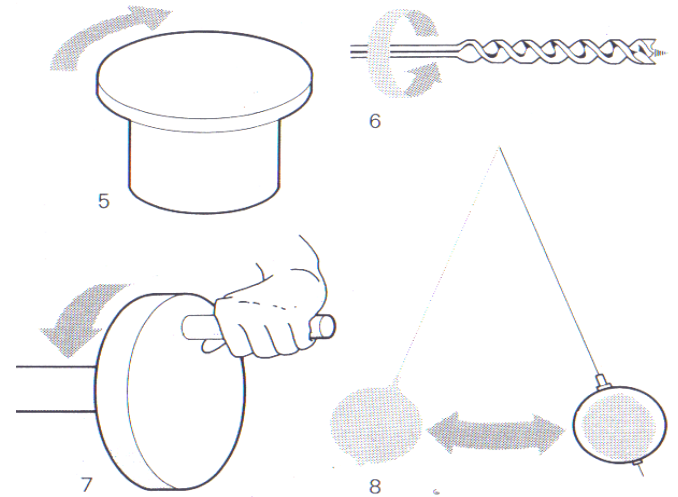
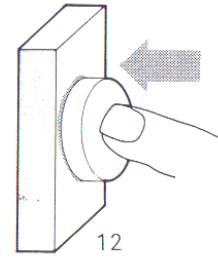

II. Which words are used to describe these directions?

in and out	backwards/away from
into	sideways/to the left
out of	sideways/to the right
up and down	through
up/upwards	along
down/downwards	across
backwards and forwards/to and fro/from side to side	round/around (clockwise/anticlockwise)
towards/forwards	

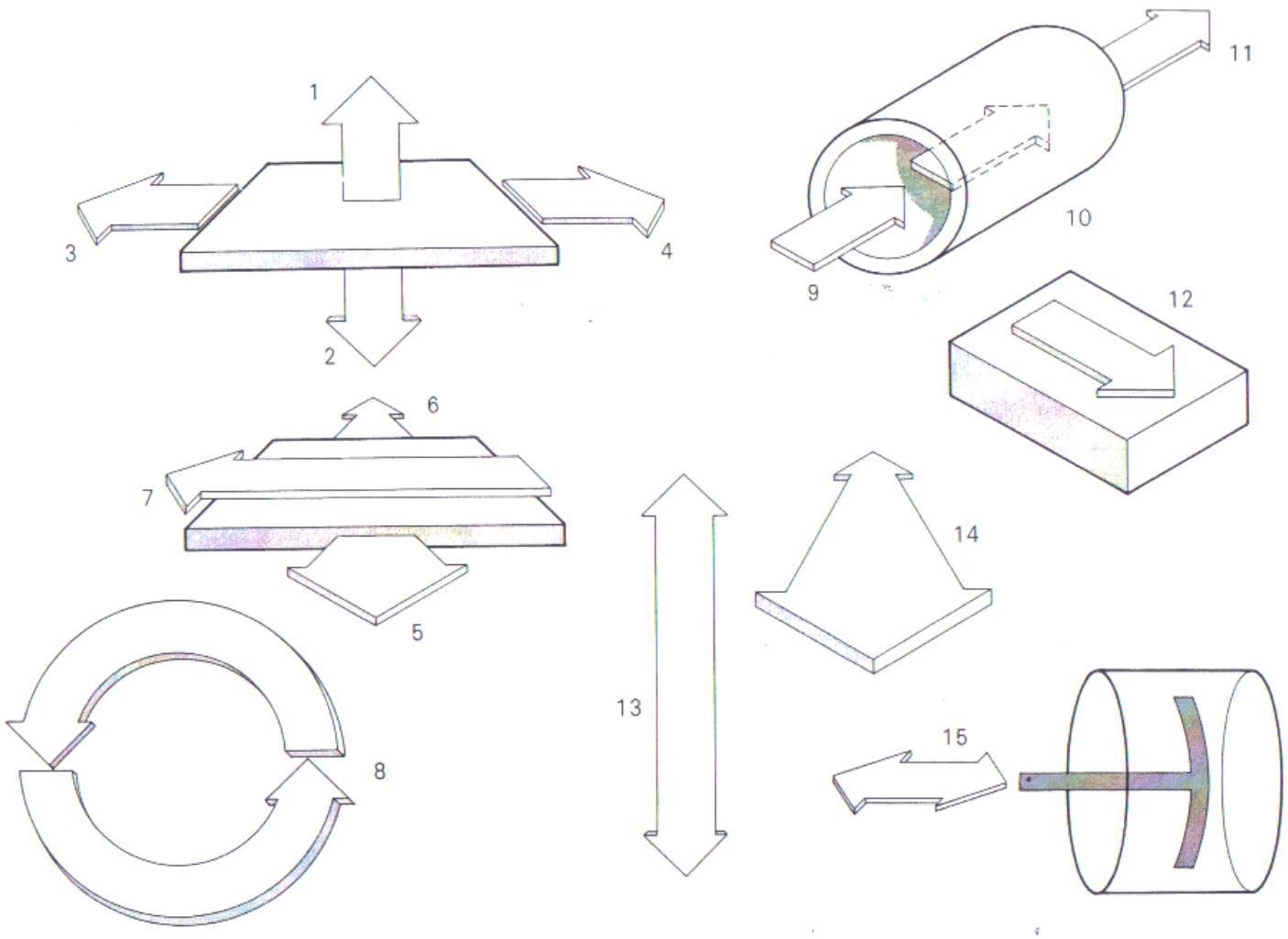

III.

a) Look at this diagram and its description.

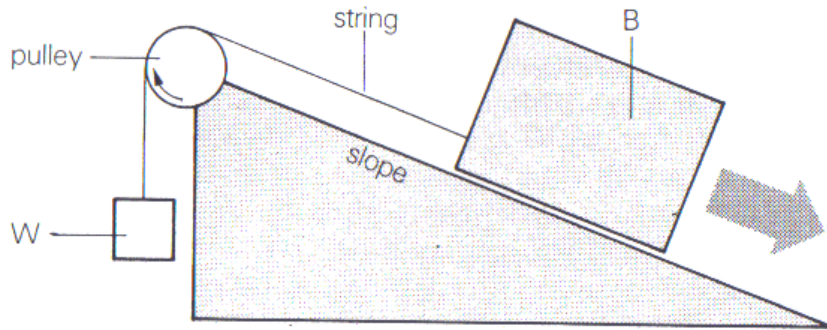

The block B rests on a slope. A string is attached to one end of the block and passes over a pulley at the top of the slope. A weight W is suspended from the end of the string.

b) Now fill in the missing words.

When the block down the slope, it..... the string andthe weight. At the same time, the pulley.....in a clockwise direction.

Useful structures

- The block pulls the string. - The string **is pulled by** the block.
- The string turns the pulley. - The pulley **is turned by means of** the string.
- The string raises the weight. - The weight **is raised by means of** the string.

EXERCISES – PASSIVE

I. Change the sentences into passive.

	SIMPLE TENSES	CONTINUOUS TENSES
	Somebody cleans the room regularly.	Somebody is cleaning the room right now.
	Somebody cleaned the room regularly.	Somebody was cleaning the room yesterday around 4 p. m.
	Somebody will clean the room regularly.	At 8 a. m., somebody will be cleaning the room.
P T E E R N F S E E C S T	Somebody has cleaned the room.	Somebody has been cleaning the room until now.
	Somebody had cleaned the room before we came.	Somebody had been cleaning the room till we came.
	Somebody will have cleaned the room before we come for the meeting tomorrow.	Somebody will have been cleaning until we come tomorrow.

II. Transform the following sentences into the passive voice.

- 1) The university will hold the final examinations in June.
- 2) You should send the answer by email.
- 3) We invited him to the lecture.
- 4) They have been developing a new device.
- 5) We must apply another technique.
- 6) They control production processes automatically.

III. Make two passive sentences.

- 1) They will show our visitors the new lab.
- 2) They gave him the required information.
- 3) They told us the result.
- 4) They have offered us several possibilities.
- 5) They taught him French at school
- 6) They teach students algebra and analytical geometry at secondary school.

IV. Compare the translations of the following sentences:

- 1) The material will be sent to different laboratories.
The material will be sent for.
The research institute will be sent the material within a week.
- 2) The book has been taken away.
The book has been taken great care of.
- 3) Back numbers of this magazine are often looked for.
Back numbers of this magazine are looked at by a number of students.
Back numbers of this magazine are well looked after by the librarian.
- 4) The lecture was given in the largest lecturing hall.
The lecture was given great attention to by the students.
Enormous amounts of energy in the form of radiation are given off.
- 5) The paper was written by professor Hoggard.
The paper was much written about at that time.
Paper is written or printed on.

V. Put verbs into the correct form – active or passive:

- 1) If atomic energy is TO USE to drive engines, it has to TO CONTROL.
- 2) It must TO PRODUCE at a small amount at a time, because the charged particles which TO GIVE OFF in the processes of atomic fission are harmful to life.
- 3) In 1945 an extremely powerful atomic bomb TO EXPLODE in the Pacific, and it TO FIND that Japanese fishermen, many miles away, TO MAKE seriously ill, or even TO KILL, by radio-active dust which TO COME DOWN from the sky.
- 4) Fish which they caught TO FIND also TO POISON by this radioactive dust.
- 5) If the chain reaction can TO CONTROL that it NOT TO ALLOW to get out of hand and become explosive, then the energy which TO WRAP UP in the atom can TO USE.

PART 4

PROCESS DESCRIPTION

USEFUL LANGUAGE, ACTIVE OR PASSIVE

PROCESS AND CYCLE DESCRIPTION

- it outlines a sequence of inter-connected stages, without gaps, that combine to describe (for example) how something is produced, how a machine works, or how a natural phenomenon such as volcanic eruption takes place
- the particular process occurs over and over again, often in a 'chain' sequence
- a particular process always consists of the same stages, in the same order.

STRUCTURE

- **introduction:** explain what the diagram shows; in the introductory sentence summarize the whole process
- **main part:** describe each stage in turn; if the process is cyclical, identify a logical place to start your description
- **conclusion:** include a brief summary of the crucial points of the report

CONTENTS

- you have to describe the main features of the data (i. e. stages and whatever the diagram explains about the processes)
- BUT you do not need to add your own information; you only report what the diagram shows
- you will probably not need (or be able) to make any comparisons

LANGUAGE

- a process is usually described using present simple (often in the passive form), occasionally present perfect is used
- a description that does not involve a process is often written in the present simple active tense (e. g. it comprises)
- a particular procedure (= a particular occasion in the past) is often described using past simple (often passive)
- it is important to mark the sequence, or order (see below table "Steps and sequencing")
- it is important to describe routes (see the table below) and to use a wide range of verbs expressing motion (ex. transport, transfer, move etc.)
- do not forget to use paragraphs in accordance with the process you describe
- it is a formal piece of writing, therefore contractions such as *don't* are not appropriate to use

Useful language

Steps and sequencing		
The first The second The next A further The final	stage step	is...
First Next Then After that*		
... and the cycle / process begins again.		

*Note that “after” is a preposition (not an adverb), and therefore it needs to be followed by a noun or a pronoun.

Routes					
From here it	passes travels moves	(along through via)	a pipe)	to	a chamber
From here there are two possible routes...					
If the sample is approved, then it moves on to... If the sample fails the test, then it...					

Saying what happens at each stage				
...into ...to	a	container chamber mixing chamber	where (things happen) in which (things happen) during which (things happen)	
			which (does things)	
The next stage is	finishing cleaning	which	involves includes	washing, brushing and polishing. three main elements:

EXERCISES

I. Look at diagram illustrating desalination process. Complete the accompanying text using words from the tables above.

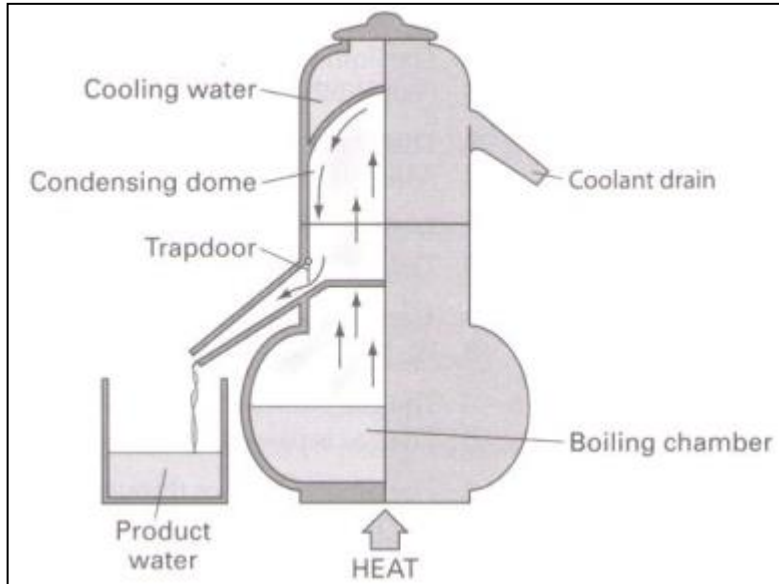

Note: A trapdoor is a small door. In this case it allows desalinated water to pass through.

(1), salt water is heated in a boiling chamber. From (2) it passes (3) a membrane (4) the condensing dome, (5) it is cooled. (6) it passes through a trapdoor and (7) the 'product water' container. In (8) the cooling water is provided by a separate system. When it has been heated by the water in the condensing dome, it flows away (9) a coolant drain.

II. In the text describing desalination process, observe the use of active and passive. Which tenses are used? Why?

ACTIVE OR PASSIVE?

- we mostly use active verbs when the focus is on people and their actions
- we mostly use passive verbs when the focus is on results, not what people do
- sometimes both forms are acceptable

*Examples: A conference brochure: Lunch is served at 1:00 p.m.
A newspaper: The government published its plans for education today.*

BY x WITH	
The cook chopped the onions with a sharp knife. Divide the square with a vertical line.	<i>instrument</i>
The guests are served by the waiter. The window was broken by wind.	<i>doer</i>
The machine is operated by turning a handle.	<i>V-ing</i>

EXERCISES

I. Decide which version of each sentence is better. Sometimes both forms (active or passive) are acceptable.

- 1) A The ingredients are mixed in a mixing chamber.
B People mix the ingredients in a mixing chamber.
- 2) A The manager chooses his team.
B A team is chosen.
- 3) A Technicians heat the water.
B The water is heated.
- 4) A The liquid is boiled.
B We boil the mixture.
- 5) A The gas passes along the pipe.
B The gas is passed along the pipe.
- 6) A The mixture passes through a filter.
B The mixture is filtered.
- 7) A The mixture is filtered through a filter.
B The mixture passes through a filter, which removes impurities.
- 8) A People test the product.
B The product is tested.
C The product undergoes testing.
- 9) A Scanners irradiate the product to kill germs.
B The product is irradiated to kill germs.
C The product undergoes irradiation to kill germs.

II. Is this funny device useful or useless? Fill in the graph with preposition **with** / **by**.

Two men are needed to operate this device: a waiter who serves the peas and a man who operates the machine _____ his right hand and eats the peas. Firstly, the peas are placed inside the metal container. Here they are kept warm _____ a flame. Secondly, the machine is operated _____ turning a small wheel. This wheel is turned _____ the man. As he turns the handle, the bottom of the container opens and closes. The peas are conveyed _____ carriers which move on the conveyor belt. At the top the peas are dropped onto the spoon. When the man pulls the string, _____ his left hand, the peas on the spoon fall into his mouth and he eats them. It is easy to eat peas _____ a spoon.

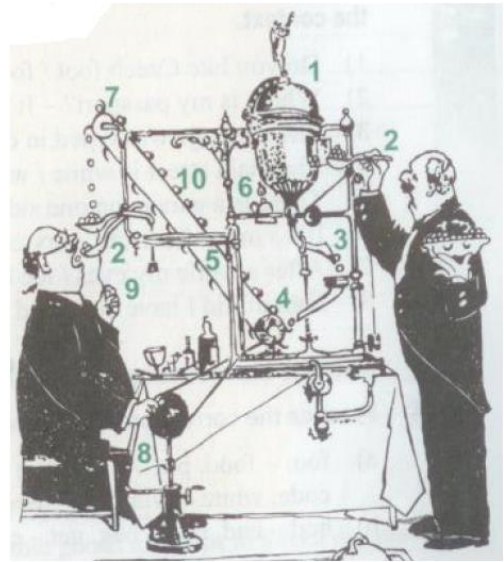

II. Read the following and then examine certain characteristics of process-writing:

The Nuclear Fission

To produce energy by means of a nuclear fission reactor, the first step is that a fast fission neutron travelling at about 42,000 Km/s is slowed down (moderated) to about 1.5 km/s when it is passed through a moderator such as 'heavy water' (D₂O). Next, the nucleus of a heavy atom such as uranium-235 is split apart by this slow-moving neutron. Splitting is accompanied by a tremendous release of energy in the form of heat, and by the release of two or three fast neutrons. These new neutrons are also slowed down by passage through the moderator. They are then used to split other U-235 atoms, which in turn release more energy and more neutrons. The result is a self-sustaining nuclear chain reaction that continually releases enormous amounts of energy

Fig. 1

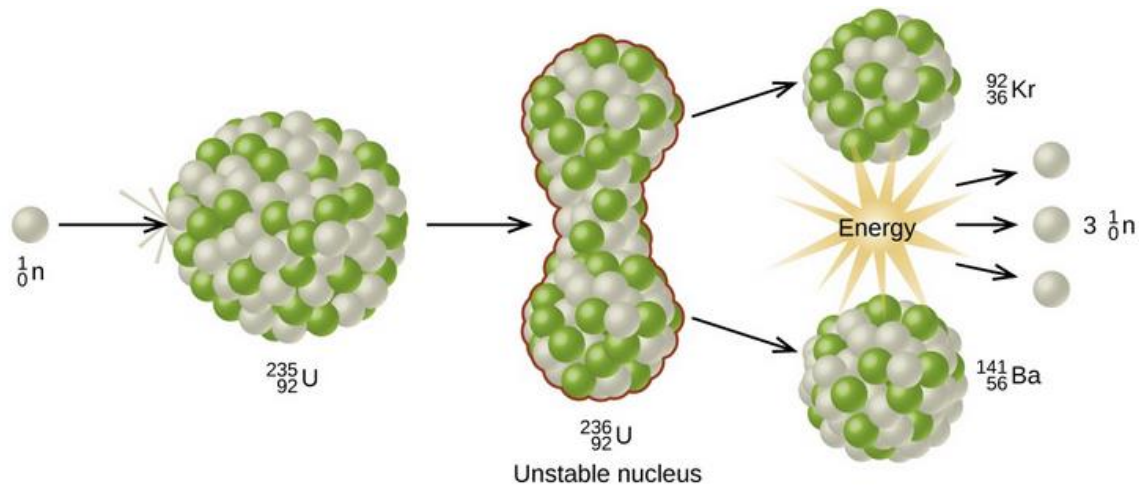

- 1) What is the function of the phrase To produce energy by means of a nuclear fission reactor..., and why is it written at the beginning of the passage?
- 2) Translate the first sentence into Czech.
- 3) What is the function of words and phrases such as the first step, next, then, in turn, the result is...?
- 4) Which is the more common: passive or active?
- 6) Form clauses of purpose:

Example: **to learn more – to work harder**

(In order) to learn more, I intend to work harder.

I intend to work harder in order that I can (may, will) learn more.

I intended to work harder in order that I could (might, would) learn more.

- | | |
|---|------------------------------------|
| a) qualify for the "zápočet" in English | d) take the exam in mathematics |
| b) perform well in quizzes | e) hand in the assignments in time |
| c) graduate from the faculty | f) take the summer off |

PART 5

CYCLE DESCRIPTION

IRREGULAR AND FOREIGN PLURALS

Which word has got these four meanings?

- a) a number of related events that happen again and again in the same order
- b) a bicycle or motorcycle (especially British English)
- c) the period of time needed for a machine to finish a process; a series of movements that a machine performs
- d) a group of songs, poems etc. that are all about a particular important event

The Nitrogen Cycle

Nitrogen is an ambiguous element. On the one hand it fertilizes plants and feeds animals. On the other hand it poisons waters and acidifies rain. Since living creatures require nitrogen to build their tissues, it is an essential element for life on earth. But, although four out of every five atoms in the air are nitrogen, it is in an inert form, i.e. it does not react with other chemical substances. Animals and plant therefore rely on a series of chemical reactions to convert it into the forms that they can use, and eventually return to the air.

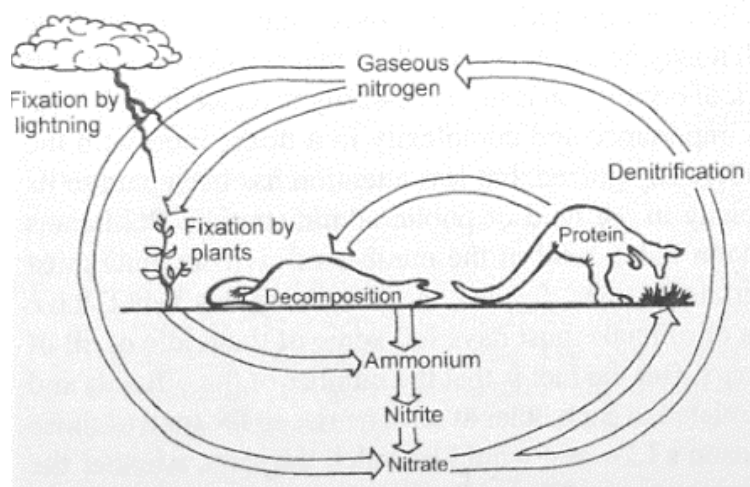

The first step is the 'fixation' of nitrogen gas by conversion to ammonia and nitrates. Lightning contributes some nitrogen, in the form of nitrates, to the soil. But the source of most nitrogen is bacteria on plants, which 'fix' the nitrogen into ammonia. The ammonia is broken down into nitrites. The nitrites are then converted into nitrates by soil bacteria. The nitrates in the soil are absorbed by plant roots. When animals eat the plant, the nitrogen the plants contain is synthesized into protein. When plants or animals die, proteins are decomposed by bacteria into amino acids which are in turn broken down into ammonia. The ammonia resulting from the decomposition returns to the nitrite-nitrate-protein cycle. Some of the nitrates are degraded into nitrogen gas in the denitrification process. This gaseous nitrogen is returned to the atmosphere. The cycle is complete.

TASKS

- In the text above, find linking words.
- How can you say "four out of every five" in another way? (Hint: use another preposition)
- Find an example of a defining relative clause
- Based on the text, decide whether the sentences are true or false.
 - Elements like nitrogen are taken from returned to the air.
 - Nitrogen does not affect water supplies.

- 3) Nitrogen is one of the elements necessary for life on earth.
- 4) Nitrogen is needed by plants and animals and human beings alike.
- 5) Proteins contain little nitrogen.
- 6) There are not many nitrogen atoms in the air.
- 7) Nitrogen present in the air is non-reactive.
- 8) Nitrogen is used by animals and plants in a changed form.
- 9) Animals and plants depend on chemical reactions for their intake of nitrogen.
- 10) In time, plants and animals return nitrogen to the atmosphere.

V. Describe the cycle by filling in the blanks.

Firstly 'fixation' takes place by of nitrogen to ammonia and nitrates. Some nitrogen, in the of nitrates, is supplied to the soil by lightning. The 'fixation' of nitrogen into ammonia is brought about by the action of bacteria. The ammonia into nitrites, which are then into nitrates by bacteria living in the soil. The nitrates by plant roots. Plants by animals and human beings and the nitrogen they is synthesized into proteins. When plant or animals die, proteins by a series of chemical reactions back into ammonia and nitrates. Some of these compounds to the nitrite-nitrate-protein cycle, some into gaseous nitrogen, which to the atmosphere.

VI. Read the following text. Then draw a diagram illustrating the process described there.

Food Chain in the Sea

The food chain describes the way in which everything in the sea seems to be eating everything else. Life in the sea begins with nutrient salts washed there by rivers. These salts feed masses of tiny plants, chiefly algae, called plankton, which drift in the sea. Plant plankton need sunlight to grow, so they are found near the sea's surface.

Plant plankton are eaten by tiny animals called animal plankton, which in turn are eaten by small fish such as herring and sprats. These fish are eaten by larger fish such as cod and haddock, a source of food for seals and dolphins; in their turn, these are eaten by killer whales.

IRREGULAR AND FOREIGN PLURALS

I. How are regular plurals formed?

II. Remember irregular plurals you know. Can you find any patterns?

LATIN/GREEK PLURALS				
1	basis analysis axis hypothesis thesis	[beisis] [ə' næləsis] [æksis] [hai' pəθisis] [θi:sis]	bases analyses axes hypotheses theses	[beisi:z] [ə' næləsi:z] [æksi:z] [hai' pəθisi:z] [θi:si:z]
2	stimulus nucleus radius focus fungus octopus	[stimjuləs] [nju:kliəs] [reidiəs] [fəukəs] [fəŋgəs] [oktəpəs]	stimuli nuclei radii foci fungi octopi / octopuses	[stimjulai / stimjuli:] [nju:kliai] [reidiai] [fəusai / fəusi: / fəukai / fəuki:] [fəŋgai / fəndžai / fəŋgi:] [oktəpai]
3	formula alga	[fo:mjulə] [ælgə]	formulae / formulas algae	[fo:mjuli:] [ældži: / ælgi: / ældžai / ælgai]
4	criterion phenomenon bacterium curriuculum medium spectrum	[krai'tiəriən] [fə'nominən] [bæk'tiəriəm] [kə'rikjuləm] [mi:diəm] [spektrəm]	criteria phenomena bacteria curriucula media spectra	[krai'tiəriə] [fə'nominə] [bæk'tiəriə] [kə'rikjulə] [mi:diə] [spektrə]
5	vertex cortex	[və:teks] [ko:teks]	vertices / vertexes cortices	[və:tisi:z] [ko:tisi:z]

EXERCISES

I. Choose the correct word for each of the following and give the plural form:

analysis, criterion, memorandum, phenomenon, formula, datum, crisis, medium

- are facts given.
- are observed events.
- are decisive moments.
- are channels of communication.
- are notes to assist the memory.
- are standards or means of judging.
- are general expressions for solving problems.
- are separations of things into their parts or components.

II. Fill in a suitable expression in the correct form (they may be used more than once).

radius, formula, datum, criterion, focus, spectrum, crisis, vertex, nucleus, curriculum vitae.

- a) The of a circle is the length of a straight line drawn between the centre and the outside edge.
- b) We had to learn many chemical at school but I can only remember H₂O for water.
- c) The was/were collected by various researchers.
- d) The Health Service should not be judged by financial alone.
- e) All the line segments extending from the centre of a circle are called
- f) In physics the point where waves of light or sound which are moving towards each other meet is called a
- g) A is a short group of letters, numbers or other symbols which represent a scientific or mathematical rule.
- h) The set of colours into which a beam of light can be separated is called a
- i) Now the is being transferred from magnetic tape to hard disc.
- j) The I apply to (= by which I decide about) any problem is "What will make me happiest?"
- k) I've passed several during my illness, but the fever's started to go down yesterday.
- l) How many are there in a triangle?
- m) Nuclear fission means the dividing of a and nuclear fusion means the joining of the two
- n) My uncle's written before and after the Velvet revolution differ a lot.

Doppler Effect

When a vibrating source of waves is approaching an observer, the frequency observed is higher than the frequency emitted by the source. When the source is receding, the observed frequency is lower than that emitted. This is known as the Doppler effect, or Doppler's principle, and is named after an Austrian physicist who lived in the first half of the 19th century. Figs 1 and 2 will help to explain this phenomenon.

Fig. 1

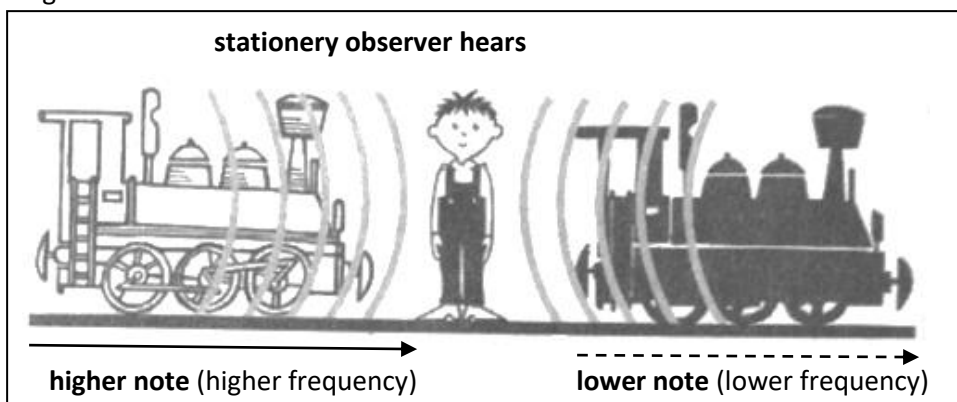
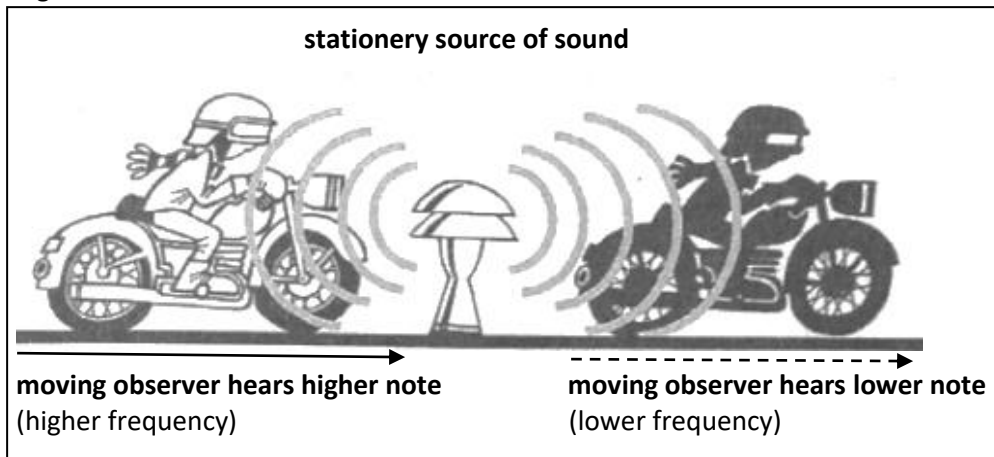
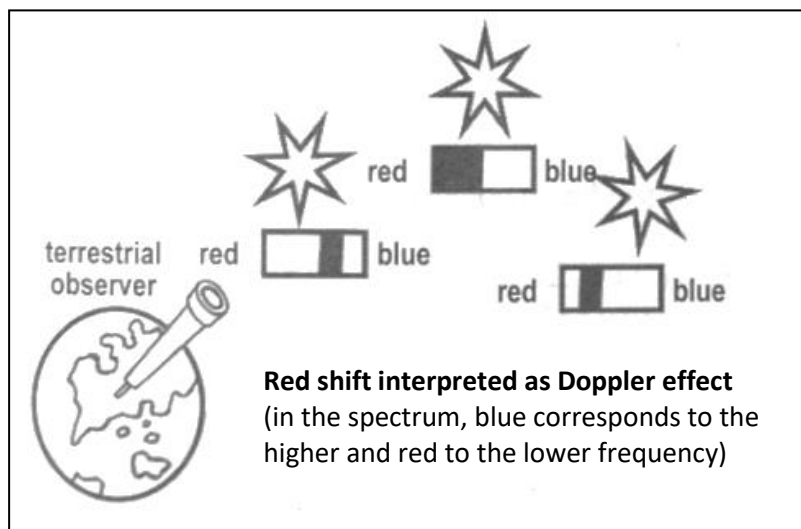

Fig. 2



The Doppler effect is widely used in astronomy for measuring the velocity at which distant stars are approaching or receding. These motions produce a shift in the position of lines in their spectra. A particular spectrum line corresponds to a certain definite light wavelength. If the star emitting the light is moving away from us, its light rays have a longer wavelength (lower frequency) by virtue of the Doppler's principle, and this is manifested in a general shift of the spectrum lines towards the end of the spectrum. This is known as the 'red shift'. Similarly, in the spectrum of a star moving towards us, the characteristic lines would show a 'blue shift', i.e. they would be displaced towards the blue end of the spectrum, corresponding to shorter wavelengths and higher frequencies. These phenomena are indicated in Fig. 3.

Fig. 3



A remarkable thing about the spectra of the spiral nebulae (the galaxies of stars far out in space beyond our own Milky Way system) is that they all display the red shift and must therefore – on the basis of Doppler's principle – all be moving away from us. The theory of the 'expanding universe' is based on this phenomenon. However, this interpretation of the red shift is disputed by some authorities.

TASKS

I. In the text above find Latin and Greek words with irregular plurals.

II. Find examples of

- a) a time clause
- b) a defining relative clause
- c) a participle

III. Is more active or passive used in the text?

IV. Write a summary of the text. You should write between 50 and 60 words. Use your own words wherever possible.

V. In the texts 'The Nitrogen Cycle' and 'Doppler Effect' find formal / everyday equivalents for the words in the table below.

everyday English	formal English
to take in	absorb
to change	
to need	
to go on	
to make possible	
	to return
to move towards	
to move away from	
	to decompose
to send out (light, heat, sound etc.)	
to disagree	
to match (or to be the same or equal)	
far away	

FORMAL AND INFORMAL LANGUAGE

I. Read the text. Then find formal expression which match these words:

to buy, to show, to correct, help

If there is a problem with your digital camera, the monitor will indicate the kind of the problem. Check the following information to see if you can remedy the problem by yourself. If you need assistance, please call the dealer where you purchased the camera.

II. Match the following technical terms with their colloquial equivalents:

- | | |
|-------------------------------------|--------------------------------------|
| 1. Remove the cover. | A) There is no data on the card. |
| 2. The text deals with computers. | B) Take off the cover. |
| 3. Insert a card. | C) Make sure that the cover is shut. |
| 4. The problem persists. | D) Put back the cover. |
| 5. The card contains no data. | E) Put in another card. |
| 6. Ensure that the cover is closed. | F) Put in a card. |
| 7. Replace the card. | G) We've still got the same problem. |
| 8. View the figure. | H) Look at the picture. |
| 9. Replace the cover | I) The text is about comps. |

III. Match formal and informal expressions:

- | | |
|---------------|-----------------|
| 1. do | A) frequently |
| 2. so | B) considerably |
| 3. often | C) eliminate |
| 4. find | D) conduct |
| 5. very | E) discover |
| 6. get rid of | F) consequently |
| 7. but | G) significant |
| 8. important | H) illustrate |
| 9. show | I) however |

CYCLE DESCRIPTION
Revision and practise

I. Describe the water cycle according to the figure below.

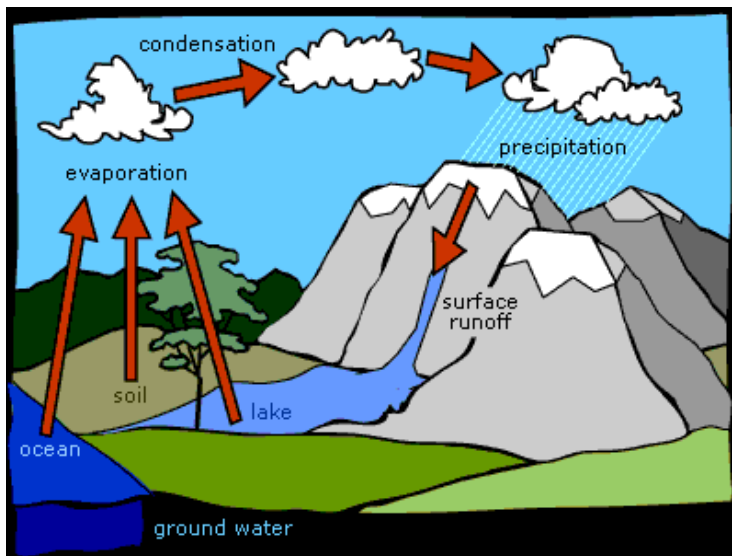

Useful vocabulary:

- evaporate
- water vapour
- atmosphere
- condense
- tiny droplets
- absorb

Note: Surface runoff is precipitation that reaches a surface stream instead of being absorbed into groundwater or evaporating.

II. Describe the process shown below. Write about 90 words.

Manufacture of bricks for for the building industry

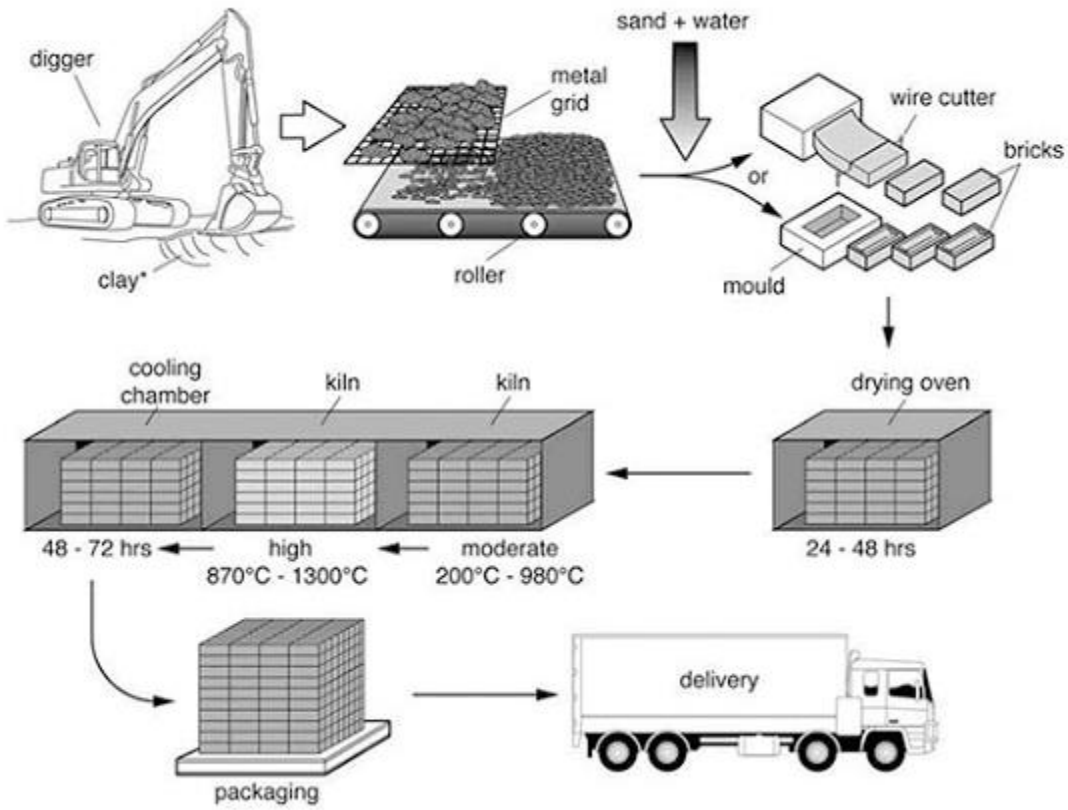

UNIT 4

DEFINITIONS

PART 1

STRUCTURE OF DEFINITIONS

1. Match the words given below with these definitions:

1. A/anis somebody who has stopped growing except around the waist.
2. A/anis somebody you know well enough to borrow money from, but not well enough to lend money to.
3. A/anis a set of holes tied together with a string.
4. A/anis somebody whose career is in ruins.
5. A/anis something one generation buys, the next generation gets rid of, and the following generation buys again.
6. A piece ofis something everybody gives but few take.
7. A/anis a mechanical device for waking up people who do not have children.
8. A/anis somebody who thinks twice before saying nothing.
9.is the only thing money cannot buy.

antique - diplomat - net - archaeologist - alarm clock - acquaintance - adult - poverty - advice

What is a good definition?

$$T = G + (d_a + d_b + d_c + \dots d_n)$$

where T equals the thing to be defined

= equals be

G equals a general class word

$d_a, d_b,$ etc. are the properties which distinguish T from the other members of the general class

Example:

A catalyst (T) is a substance (G) which alters the rate at which a chemical reaction occurs (d_a), but is itself unchanged at the end of the reaction (d_b).

i.e., $T = G + d_a + d_b.$

EXERCISES

I. The definitions below have been mixed up. Write them correctly:

An X is a/an class word wh-word

A machine device which converts one form of energy into another.

A dynamo device which attracts bodies towards the centre of the earth.

A triangle machine which measures temperature.

Gravity figure which generates electricity.

A thermometer device which has three sides.

An engine force which enables us to use forces more conveniently.

A device can be broken down into these general class words:

1. An apparatus is a number of devices which are put together for a particular purpose as in physics or chemistry experiments.
2. An instrument is a device which is used in doing something, often of a sensitive nature. Typical examples are a microscope and an ammeter.
3. A machine is a mechanical device which is used to provide power.
4. A tool is a simple device, often without any moving parts. Examples are a hammer and a spanner.
5. Instrumentation is a group or collection of instruments, usually ones that are part of the same machine.
6. Equipment comprises the tools, machines, or other things necessary for a particular job or activity.

II. Choose the correct general class words:

1. A screwdriver is a (an) tool/apparatus which tightens or loosens screws.
2. A drill is an instrument/apparatus which bores holes.
3. A condenser is a (an) equipment/tool which converts vapour into liquid.
4. An ammeter is a (an) machine/instrument which measures electrical current.
5. A fan is an instrument/apparatus which circulates air.
6. A generator is a (an) apparatus/machine which produces electricity.

III. Change the following descriptive statements into definitions. Use these class words:
a device, an instrument, a piece of furniture, a form of energy.

1. A table has a flat horizontal surface supported by legs, and is used to sit at for meals, for working, etc.
2. A watch is used for measuring and indicating time.
3. A calculator can carry out number operations, but usually has no memory.
4. A telegraph receives or sends messages along wire by means of electric signals.
5. Electricity is used for heating and lighting and to provide power for machines in houses and factories.

PART 2

TYPES OF DEFINITIONS

T - the word to be defined

G – general class word

DF – defining feature (distinguishing the T from the others of the same class; it states its use, function, size and shape, material, composition, structure, properties, etc.)

A/an T	is is defined as may be defined as	a/an G	DF
A/an T	is a name for is a name applied to	a/an G	DF
The name T term T	denotes refers to may be applied to	a/an G	DF
By a/an T	is meant is understood	a/an G	DF
A/an G	DF	is called may be called	a/an T

Examples:

1. A loudspeaker is a device used for converting variations of electric energy into corresponding variations of acoustic energy, i.e. sound.
2. E-mail is a name applied to a software application which allows people to communicate via the Internet.
3. The term ultrasonics (or supersonics) refers to sound vibrations whose frequencies are beyond auditory limit.
4. By noise is understood sound consisting of a mixture of air-borne vibrations which is completely irregular with regard to sound intensity, frequency, and phase.
5. The force with which the earth attracts an object, i.e., the gravitational force exerted upon it, is called weight.

I. Reformulate the following definitions:

1. A switch is a general name for a device used for effecting the completion and interruption of an electric circuit.
2. "Dry ice" is a name sometimes applied to compressed carbon dioxide, i.e., solid carbon dioxide with a temperature of -79°C .
3. The name "radar" denotes a method of scanning the surrounding space by means of high frequency radio waves, which are sent out from a powerful transmitter and are reflected by any object which they encounter. The name has been derived from the initial letters of the phrase "radio detecting and ranging".
4. Fiction refers to books or stories about people and events invented by the author, rather than books about real events and things.
5. The science of determining the position and course of ships and aircraft is called navigation.

II. Form definitions of different kinds:

1. Biology studies living things.
2. Physics is concerned with the study of matter and natural forces, such as light, heat, movement, etc.
3. A watch is used for measuring and indicating time.
4. A calculator can carry out number operations, but usually has no memory.
5. A telegraph receives or sends messages along wire by means of electric signals.
6. A telephone receives or sends sound, especially speech over long distances by electric means.
7. A computer can store and recall information and make calculations at very high speed.
8. Ecology is concerned with the study of the pattern of relationships of plants, animals, and people to their surroundings.
9. A bed consists of a flat rectangular surface about 2 metres long with a leg at each corner. It is used for sleeping.
10. The function of a thermometer is to measure temperature.
11. The function of an air-conditioning system is to keep the temperature and humidity of the air in rooms at values which provide a sense of comfort for human beings.
12. The function of a seismograph is to record the strength of earthquakes and the distance away from the epicentre.

Expressing distinctive features		
1. Purpose and function	A T is a G (which is)	used for doing used to do
	A T is a G	<i>prepositional phrase</i> (examples: <i>A wrench is a metal tool <u>for holding and turning objects.</u></i> <i>Physiology is the scientific study <u>of the normal function of living things.</u></i>
2. Material	A T is a G (which is)	made from/of produced from obtained from prepared in the laboratory
3. composition and structure	A T is a G (which is)	composed of
	A T is a G	consisting of containing
4. General appearance	G which is G which is	
	A T is a G	having

TASK

Work in pairs. Think of three ordinary object you use or see every day. For each of them write two kinds of definition (starting with the name of the object / starting with a class word). Test them on another student by blanking out the "thing defined" word and see whether he or she knows what you have defined.

Example: A writing instrument which consists of a long thin piece of wood with a piece of graphite in the middle is called (a pencil)

ad 2. Material

MADE OF X MADE FROM / OUT OF

Observe:

This table is made of wood.	<i>We are talking about material.</i>
Most of these buildings are made of bricks.	
Petrol is made from oil.	<i>We are talking about a process.</i>
Paper is made from /out of wood.	

Fill in the correct preposition:

1) Most plastics are made _____ oil. 2) All of these decorations are made _____ paper. 3) This shirt is made _____ cotton. 4) Glass fibre is a cloth made _____ short thin threads of glass. 5) Glassware is objects made _____ glass, for example bowls, drinking containers, and ornaments. 6) Porridge is a thick, sticky food made _____ oats cooked in water or milk and eaten hot, especially for breakfast. 7) Most wind instruments are made _____ brass. 8) He made a chair _____ bits of wood.

ad 3. General appearance

AS x LIKE

AS		Examples
1. talking about the job, function, status, age, role or use of a person or thing <i>(in Czech: jakožto)</i>	+ nouns/ pronouns ing-forms	<i>Over the summer she worked as a waitress. He went to the party dressed as a big strawberry. We all work together as a team.</i>
2. used in comparisons asas	adjective/adverb	<i>He is as good at mathematics as his classmates.</i>
3. used in expressions not so... as* the same (...) as		<i>He wouldn't go so far as that. He is the same age as me.</i>
4. talking about similarity <i>(in Czech: stejně jako)</i>	+ a clause with a verb prepositional expression	<i>His colleagues spoke and thought <u>as he did</u>. He admired her, as he admired her mother. In France, as in Italy, they speak a Romance language.</i>

LIKE		Examples
1. talking about similarity	+ nouns/ pronouns ing-forms	<i>I am very like my father. The garden looked like a jungle. Like other people, he values his privacy. His colleagues spoke and thought <u>like him</u>. *</i>

* Compare the sentences (the meaning is the same).

* "Not as... as" is also considered correct today.

Observe:

He worked like a slave. He worked as a slave.	= very hard indeed = he was a slave
He spoke like the President of the United States. He spoke as the President of the United States.	= in a similar manner = he was the president

Fill in **as** or **like**, as appropriate:

- 1) We used an empty plastic shopping bag _____ a wastepaper basket.
- 2) _____ a historian, I cannot agree with this interpretation.
- 3) I saw a dog _____ ours on the beach.
- 4) He's _____ a little baby.
- 5) The sudden change came _____ a shock to the community.
- 6) She was known to her neighbours _____ a kind old lady.
- 7) It was a small pocket flashlight shaped _____ a fountain pen.
- 8) I never expected to earn my living _____ an artist.
- 9) My watch said four o'clock but it looked _____ early evening.
- 10) This fruit tastes _____ a mango.
- 11) It was a story she had heard many times _____ a girl.

OTHER MEANINGS OF "AS" (conjunction)

Observe:

As there was nothing to do, he went home.	as = because
He counted them as they arrive.	as = when, while

Decide which meaning has **as** in the following sentences:

- 1) I saw him as he was getting off the bus.
- 2) He saw her, as they were both getting off the bus at the same time.
- 3) She stayed at home as she was not feeling well.
- 4) As I've never met the man, I can't tell you what he looks like.
- 5) As he stood there he saw two men enter the shop.
- 6) As this book is written in simple English, it is suitable for beginners.
- 7) As he was posting the letter, he suddenly realized that he hadn't put a stamp on the envelope.
- 8) As we were tired after the long walk, we went to bed early.

PART 3

VARIATIONS IN DEFINITIONS

Expanded definition

- a definition can be expanded by giving an example of the use of the object or idea being defined
- the relationship between the definition and its use can be made explicit by using an appropriate linking expression
- for instance, the use which is an effect of the definition, can be marked by linking expressions **therefore, consequently, as a result** etc.

Examples:

Aluminium is a metal which is light in weight. Consequently, it is used in the manufacture of aircraft.

..... *Therefore, it is used...*

..... *As a result, one of its main uses is....*

EXERCISES

1. Use the pattern described above to expand the following definitions:

- 1) Glass is a substance which has the property of being transparent.
- 2) Stainless steel is an alloy which is resistant to corrosion.
- 3) Sugar is a substance, often in the form of white or brown crystals, which has the property of being sweet.
- 4) Cotton is a soft natural fibre with a good level of absorbency and good insulating properties.

Reduced definitions

Observe:

1. A thermometer is an instrument **which is used for** measuring temperature.
2. A thermometer is an instrument **used for** measuring temperature.
3. A thermometer is an instrument **for** measuring temperature.

1. A telescope is an optical instrument **which consists of** a combination of lenses and mirrors which make distant objects appear closer.
2. A telescope is an optical instrument **consisting of** a combination of lenses and mirrors which make distant objects appear closer.

Use this pattern to reduce the following definition:

- 1) A watch is an instrument which is used for measuring and indicating time.
- 2) A person who studies living things is called a biologist.
- 3) A vegetable is a plant which is eaten either raw or cooked.
- 4) Electricity is a form of energy used for heating and lighting.

Emphasizing the agent

I. The agent of an action can be stressed by placing it at the end of your answer. Some necessary changes to the sentence have to be made:

Example: *Who discovered America? (Christopher Columbus) → America was discovered by Christopher Columbus.*

Answer the questions in a similar way:

- 1) Who showed the visitors round? (an English speaking guide)
- 2) Who checked every component before it was put in place? (a firm of independent engineers)
- 3) What runs the air-conditioning of the tunnel? (an independent electronic system)
- 4) What can prevent many diseases? (a well-balanced diet)
- 5) What causes the greenhouse effect? (gases released into the atmosphere)

II. IT IS / IT WAS for emphasis.

Observe:

Salmonella bacteria cause food poisoning.

- **It is** salmonella bacteria **that** cause food poisoning
- **It is** food poisoning **that** salmonella bacteria cause.

In 1962 American doctors claimed that effective immunization against the common cold would be available within five years.

- **It was** in 1962 **that** American doctors claimed that effective immunization against the common cold would be available within five years.
- **It was** American doctors **who / that** claimed in 1962 that effective immunization against the common cold would be available within five years.
- **It was** effective immunization against the common cold **that** in 1962 American doctors claimed would be available within five years.
- **It was** within five years **that** in 1962 American doctors claimed that effective immunization against the common cold would be available.

Note: The verb cannot be emphasized in this way.
Always use "It is/it was" (singular).

Emphasize parts of these sentences:

- 1) *Louis Pasteur developed the treatment of milk and wine.*
- 2) *Manufacturers spend millions of dollars every year on advertisement.*
- 3) *Good health is an important factor in making people happy.*
- 4) *The common cold is caused by more than 100 different viruses.*
- 5) *Health matters matter to everyone.*

Literature and resources:

JORDAN, R. R. *Academic Writing Course. Study Skills in English*. Harlow: Pearson Education Limited, 2003. ISBN 0582 40019 8.

MCCARTHY, Michael a O'DELL, Felicity. *Academic vocabulary in Use*. Cambridge: Cambridge University Press, 2008. ISBN 978-0-521-68939-7.

MURPHY, Raymond. *English Grammar in Use*. Cambridge: Cambridge University Press, 2012. ISBN 978-0-521-18906-4.

PROCTER, Paul, ed. *Cambridge international dictionary of English*. Cambridge: Cambridge University Press, 1996. ISBN 0-521-48469-3.

STRNADOVÁ, Zdenka. *Aiming to Advance*. Voznice: Leda, 2010. ISBN 978-80-7335-227-1.

SWALES, John. *Writing Scientific English*. Sunbury-on-Thames: Nelson, 1979.

WILLIAMS, Ray. *Panorama*. Harlow: Longman, 1991. ISBN 0-582-55358-X

<https://www.ieltsbuddy.com/ielts-process-diagram.html>

<https://takeielts.britishcouncil.org>

[https://chem.libretexts.org/Bookshelves/Introductory_Chemistry/Map%3A_Fundamentals_of_General_Organic_and_Biological_Chemistry_\(McMurry_et_al.\)/11%3A_Nuclear_Chemistry/11.09%3A_Nuclear_Fission_and_Nuclear_Fusion](https://chem.libretexts.org/Bookshelves/Introductory_Chemistry/Map%3A_Fundamentals_of_General_Organic_and_Biological_Chemistry_(McMurry_et_al.)/11%3A_Nuclear_Chemistry/11.09%3A_Nuclear_Fission_and_Nuclear_Fusion)

<http://www.cotf.edu/ete/modules/mse/earthsysflr/water.html>